

Toroidal Core Potting Boxes (H-RG) for horizontal pcb mounting

The potting boxes are made in gfr Polyamide PA66 of type A RV250 nat. (RTI long-range temperature +100 °C). Pin material: tin bronze, tinned. Maximum solder temperature 350 °C, 2 sec. Special materials – e.g. irradiated cross-linked – and designs on request, dimensions in mm/inch.

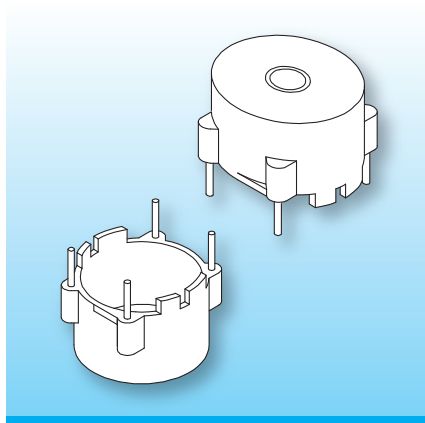

Potting boxes for horizontal pcb mounting. The centre hole can be easily removed for applications requiring a feed-through. The design features “stand offs” to the pcb to eliminate cold soldering, or can be used as positioning aid.

Type	Order-Code	Accessories
Box: H-RG 35.0/25.0-28.5/-1/A RV250 nat. Solder-pin: z112/ua	66344-106 73322-212	on request

wound toroidal core

diameter $\varnothing 40.0/\varnothing 1.575$
width 25.5/1.004

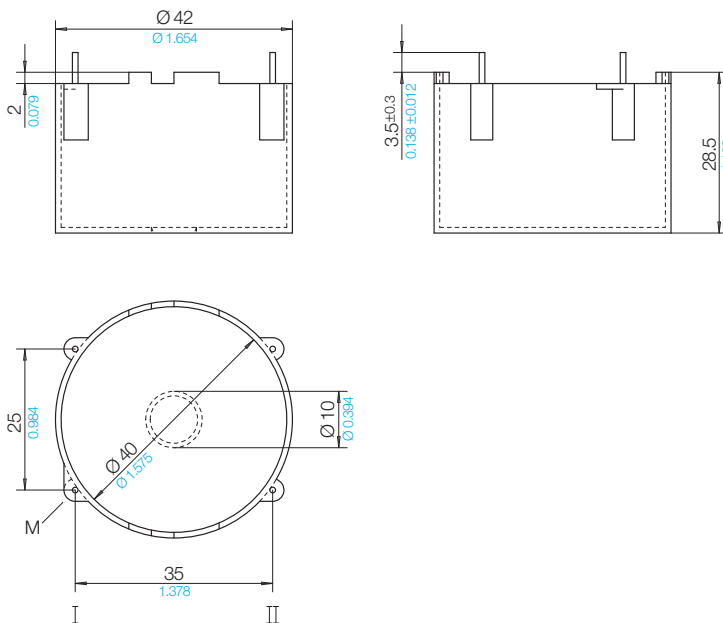

Grid View pin-side

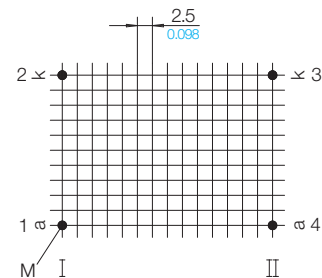

16 A 2 S

© 08/2018 by NORWE GmbH

Warranties:
refer to Terms and Conditions of Sale

NORWE GmbH

Postfach 13 56
51691 Bergneustadt
Paulstraße 5, Pernze
51702 Bergneustadt
Deutschland
Telefon +49 (0) 27 63-807-0
Telefax +49 (0) 27 63-807-77
E-mail verkauf@norwe.de
Internet www.norwe.de
www.norwe.eu

NORWE Inc.

P.O. Box 25 11
North Canton, OH 44720-0511
United States of America
Telefon +1-330 497-8113
Telefax +1-330 305-0592
E-mail usa@norwe.com
Internet www.norwe.com



Valid version of
data sheet online

QR Online-Version