

Horizontal Potting Box (HB)

The potting boxes are made in gfr Polyamide PA66 of type p6g (RTI long-range temperature +125°C). Pin material: tin bronze, tinned. Maximum solder temperature 350°C, 2 sec. Special materials – e.g. irradiated cross-linked – and designs on request, dimensions in mm/*inch*.

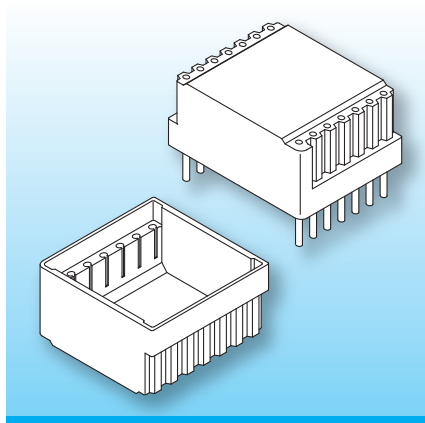

Potting boxes for PCB mounting of toroidal cores. Depending on how the pins are fitted, the box can be pcb mounted potting side up or down. If there are no specific instructions, side A will be supplied.

Type	Order-Code	Accessories
Box: HB 10.0/12.5-8.0/-8/p6g Solder-pin: r811/ua	66320-024 77311-212	on request

wound toroidal core

diameter Ø 11.3/Ø 0.445
width 6.3/0.248

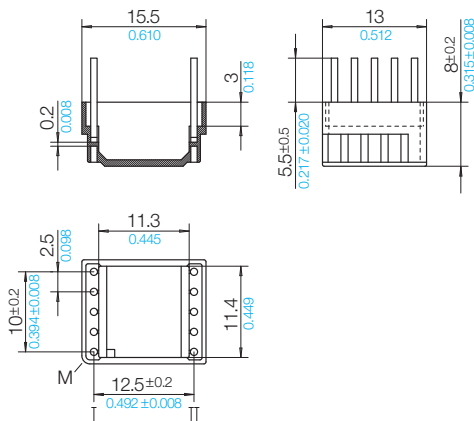

Grid

View open side of box

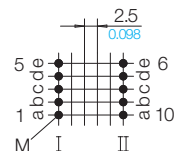

© 04/2014 by NORWE GmbH

Warranties:
refer to Terms and Conditions of Sale

NORWE GmbH

Postfach 13 56
51691 Bergneustadt
Paulstraße 5, Pernze
51702 Bergneustadt
Deutschland

Telefon +49 (0) 27 63-807-0
Telefax +49 (0) 27 63-807-77
E-mail verkauf@norwe.de
Internet www.norwe.de
www.norwe.eu

NORWE Inc.

P.O. Box 25 11
North Canton, OH 44720-0511
United States of America
Telefon +1-330 497-8113
Telefax +1-330 305-0592
E-mail usa@norwe.com
Internet www.norwe.com



Valid version of
data sheet online

QR Online-Version