

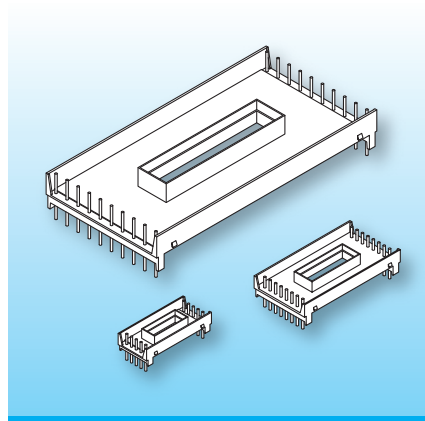

PLANAR Coilformers – Solder Connect

The planar coilformers are made in gfr Polyamide PA66 of type A RV250 nat. (RTI long-range temperature +100°C).
 Pin material: tin bronze, tinned.
 Maximum solder temperature 350°C, 2 sec.
 Special materials – e.g. irradiated cross-linked – and designs on request, dimensions in mm/inch.



Planar coilformers with solder-connections were developed for individual and easily changeable winding designs. Electrical connections are via solder-pins located outside the core-area. This also allows the use of different winding carriers, pcb, foil or copper stamping in the same winding design.

Type	Order-Code	Accessories
Coilformer: E 14-5/Planar/6-8/A RV250 nat. Solder-pin: z810/ua	N0650-106  73296-212	on request

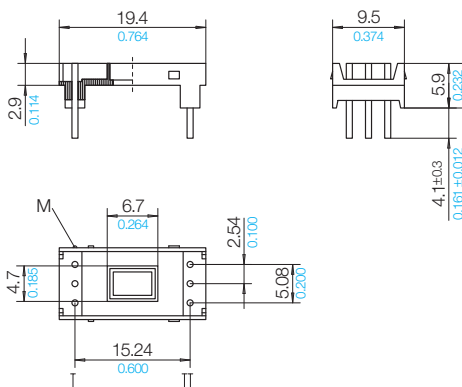

Grid
View pin-side

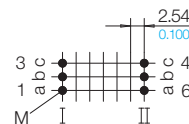

14 A 0 K

© 08/2018 by NORWE GmbH

Warranties:
refer to Terms and Conditions of Sale

NORWE GmbH

Postfach 13 56
 51691 Bergneustadt
 Paulstraße 5, Pernze
 51702 Bergneustadt
 Deutschland
 Telefon +49 (0) 27 63-807-0
 Telefax +49 (0) 27 63-807-77
 E-mail verkauf@norwe.de
 Internet www.norwe.de
 www.norwe.eu

NORWE Inc.

P.O. Box 25 11
 North Canton, OH 44720-0511
 United States of America
 Telefon +1-330 497-8113
 Telefax +1-330 305-0592
 E-mail usa@norwe.com
 Internet www.norwe.com



Valid version of
data sheet online

QR Online-Version