

EI, UI Coilformers

The coilformers are made in Polyamide PA66 gr, UL 94 HB, temperature for longterm use at +130 °C. The material used is tin bronze, tinned (solder-pins) or brass, tinned (solder-tags). Maximum solder temperature 350 °C, 2 sec. (Special materials and designs on request, dimensions in mm/inch).

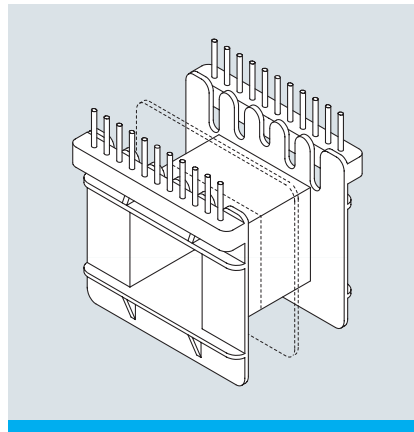

Due to their designs with different connection systems (press-fit pins, bent over pins, soldertags, etc.) the coilformer-versions allow radial as well as axial binding on of the wires, matching your individual fields of application.

We are about to draw up a catalogue of this extensive series step by step – you will find the latest survey of available components on our homepage. For special designs and dimensions as well as available accessories please contact our technical specialists.

Type	Order-Code	Accessories
Coilformer: EJ 48/1k/2-8/2.5-kl/p6g	05620-024	Potting Box EJ 48/vlc
Coilformer: EJ 48/2k/2-8/2.5-kl/p6g	05621-024	
Solder-pin: z810/ua	73296-212	

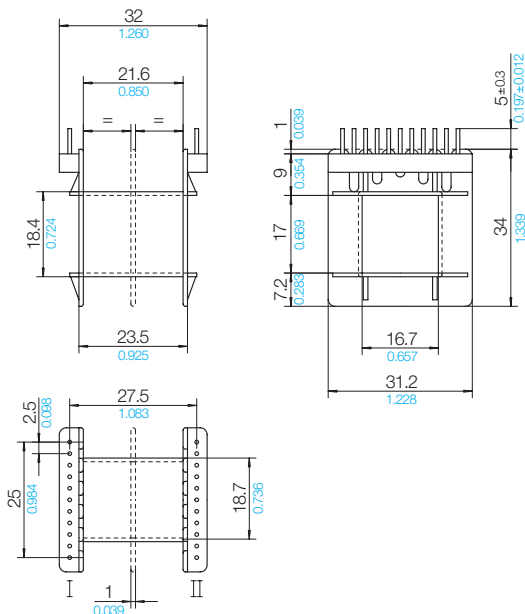

Grid
View pin-side

