

## EI, UI Coilformers

The coilformers are made in Polyamide PA66 gfr, UL 94 HB, temperature for longterm use at +130 °C. The material used is tin bronze, tinned (solder-pins) or brass, tinned (solder-tags). Maximum solder temperature 350 °C, 2 sec. (Special materials and designs on request, dimensions in mm/*inch*).

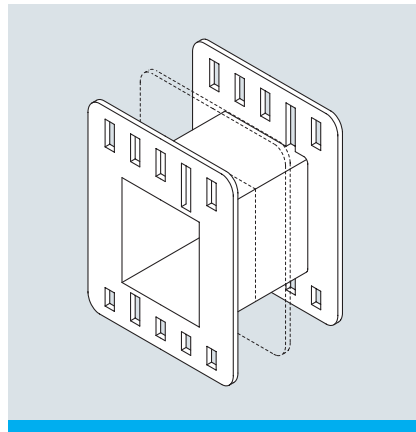

Due to their designs with different connection systems (press-fit pins, bent over pins, soldertags, etc.) the coilformer-versions allow radial as well as axial binding on of the wires, matching your individual fields of application.

We are about to draw up a catalogue of this extensive series step by step – you will find the latest survey of available components on our homepage. For special designs and dimensions as well as available accessories please contact our technical specialists.

Type	Order-Code	Accessories
Coilformer: EJ 48/1k/bb/p6g	05500-024	on request
Coilformer: EJ 48/2k/bb/p6g	05501-024	

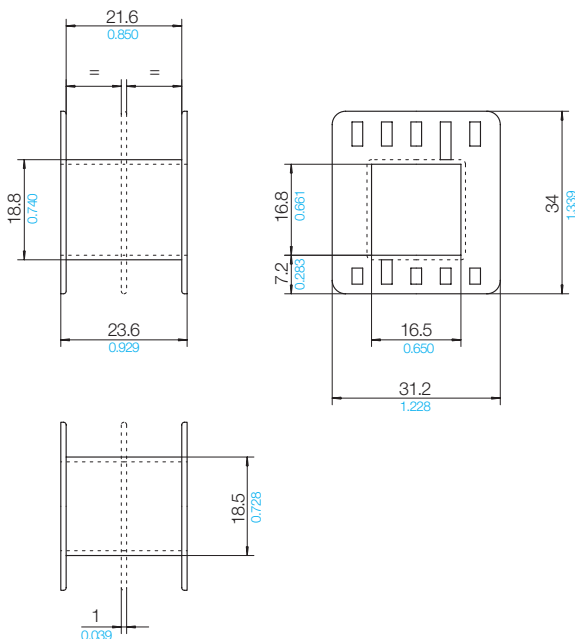

© 03/2005 by NORWE GmbH

All dimensions in mm/inch

The permissible deviations according to DIN 16901 apply as tolerances

Warranties: refer to Terms and Conditions of Sale

### NORWE GmbH

Postfach 13 56  
D-51691 Bergneustadt

Paulstraße 5, Pernze  
D-51702 Bergneustadt

Telefon +49 (0) 27 63-8 07-0  
Telefax +49 (0) 27 63-8 07-77  
E-mail verkauf@norwe.de  
Internet www.norwe.de

### NORWE Inc.

P.O. Box 25 11  
USA- North Canton, OH 44720-0511

Telefon +1-330 497-8113  
Telefax +1-330 305-0592  
E-mail usa@norwe.com  
Internet www.norwe.com