

## EI, UI Coilformers

The coilformers are made in Polyamide PA66 gfr, UL 94 HB, temperature for longterm use at +130 °C. The material used is tin bronze, tinned (solder-pins) or brass, tinned (solder-tags). Maximum solder temperature 350 °C, 2 sec. (Special materials and designs on request, dimensions in mm/*inch*).

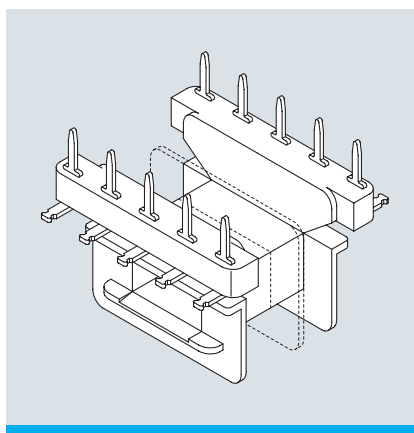

Due to their designs with different connection systems (press-fit pins, bent over pins, soldertags, etc.) the coilformer-versions allow radial as well as axial binding on of the wires, matching your individual fields of application.

We are about to draw up a catalogue of this extensive series step by step – you will find the latest survey of available components on our homepage. For special designs and dimensions as well as available accessories please contact our technical specialists.

Type	Order-Code	Accessories
Coilformer: EJ 30-5/1k/7g2-/5.0-ii/p6g	04240-024	on request
Coilformer: EJ 30-5/7-5k/7g2-/5.0-ii/p6g	04241-024	
Solder-tag: g2c/wc	71070-259	

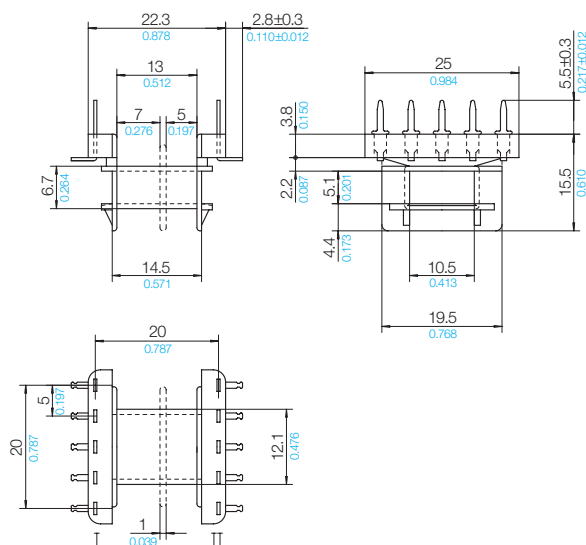

## Grid

View pin-side

