

EJ 38 – EJ 96b Coilformer elements

The components are made in grf Polyamide PA66 of type p6g (RTI long-range temperature +125°C). Pin material is tin bronze, tinned or brass, tinned for tags. Maximum solder temperature 350°C, 2 sec. Special materials – e.g. irradiated cross-linked – and designs on request, dimensions in mm/inch.

The coilformer elements are sorted according to size.

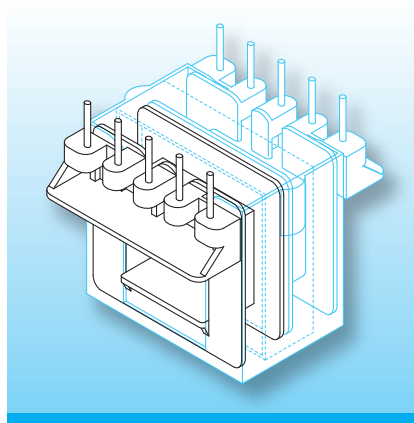

The primary and secondary areas can be wound in separate working steps and the design also permits alternative connection systems.

The selection of components listed below is essential to a complete coilformer. The design are marked A, B or C.

Type	Order-Code	Component-Selection
Coilformer: EJ 78/x/k/p6g	08101-024	C 2 x housing EJ 78/g 1 x frame EJ 78/r

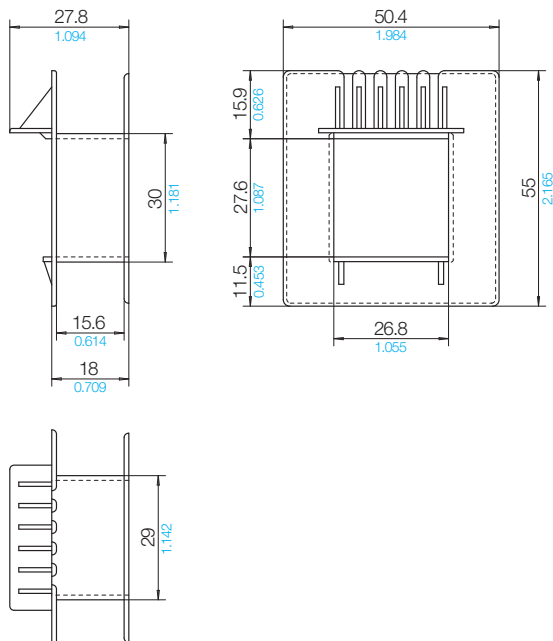

© 07/2012 by NORWE GmbH

All dimensions in mm/inch

The permissible deviations according to DIN 16901 apply as tolerances

Warranties:
refer to Terms and Conditions of Sale



Valid version of
data sheet online

QR Online-Version

NORWE GmbH

Postfach 13 56
51691 Bergneustadt
Paulstraße 5, Pernze
51702 Bergneustadt

Deutschland

Telefon +49 (0) 27 63-807-0
Telefax +49 (0) 27 63-807-77
E-mail verkauf@norwe.de
Internet www.norwe.de
www.norwe.eu

NORWE Inc.

P.O. Box 25 11
North Canton, OH 44720-0511
United States of America

Telefon +1-330 497-8113
Telefax +1-330 305-0592
E-mail usa@norwe.com
Internet www.norwe.com