

## M 42 – M 102b Coilformer elements

The components are made in grf Polyamide PA66 of type p6g (RTI long-range temperature +125°C). Pin material is tin bronze, tinned or brass, tinned for tags. Maximum solder temperature 350°C, 2 sec. Special materials – e.g. irradiated cross-linked – and designs on request, dimensions in mm/inch.

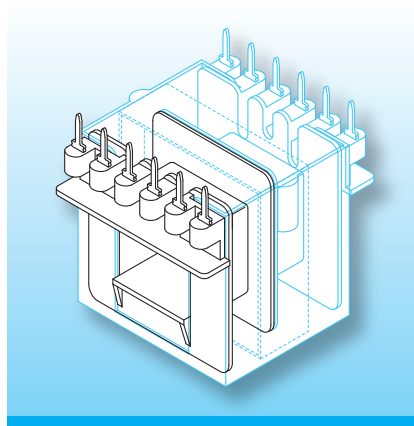

The coilformer elements are sorted according to size. The primary and secondary areas can be wound in separate working steps and the design also permits different connection systems.

The selection of components listed below and marked according to design A, B or C is essential to a complete coilformer.

Type	Order-Code	Component-Selection
Coilformer: M 74/x/k/p6g	03801-024	C 2 x housing M 74/g 1 x frame M 74/r

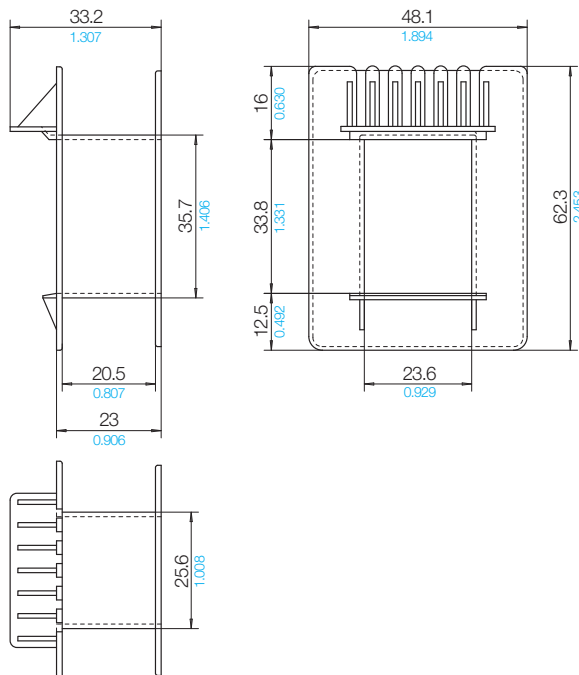

### © 07/2012 by NORWE GmbH

All dimensions in mm/inch

The permissible deviations according to DIN 16901 apply as tolerances

Warranties:  
refer to Terms and Conditions of Sale



Valid version of  
data sheet online

QR Online-Version

### NORWE GmbH

Postfach 13 56  
51691 Bergneustadt  
Paulstraße 5, Pernze  
51702 Bergneustadt

Deutschland

Telefon +49 (0) 27 63-807-0  
Telefax +49 (0) 27 63-807-77  
E-mail verkauf@norwe.de  
Internet www.norwe.de  
www.norwe.eu

### NORWE Inc.

P.O. Box 25 11  
North Canton, OH 44720-0511  
United States of America

Telefon +1-330 497-8113  
Telefax +1-330 305-0592  
E-mail usa@norwe.com  
Internet www.norwe.com