

UNI EJ Coilformers

The coilformers are made in gfr Polyamide PA66 of type p6g (RTI long-range temperature +125°C) Pin material is tin bronze, tinned for solder-pins and brass, tinned for solder-tags. Max. solder temperature +350°C, 2 sec. Special materials – e.g. irradiated cross-linked – and designs on request, dimensions in mm/*inch*.

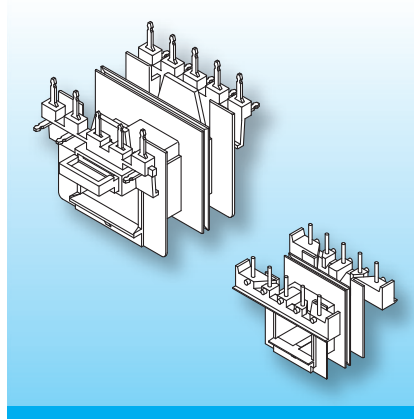

The coilformers are fitted with solder-pins and solder-tags. By fitting shrouds and insulating bridges creepage- and clearance distances of 11 mm/*0.433 inch* are achieved between primary and secondary, and 6 mm/*0.236 inch* to the core.

Elaborate description of the designs with the different implementations, see at catalogue.

Type	Order-Code	Accessories
Coilformer: EJ 38-13/9z-6s/2g2-/5.0-ik/p6g	20126-024	Shroud EJ 38-13/9-6v
Solder-tag: s14/wd	75508-261	Insulating Bridge EJ 38
Solder-tag: s11/wc	75315-259	Thermoclip (on request)

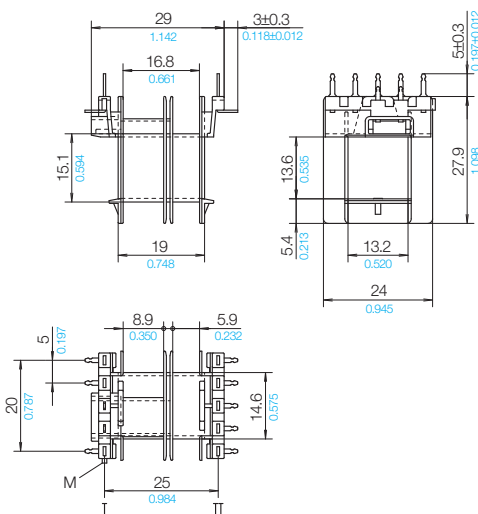

Grid View tag-side

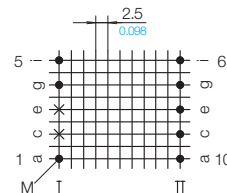

© 06/2012 by NORWE GmbH

All dimensions in mm/inch

The permissible deviations according to DIN 16901 apply as tolerances

Warranties:
refer to Terms and Conditions of Sale



Valid version of
data sheet online

QR Online-Version

NORWE GmbH

Postfach 13 56
51691 Bergneustadt
Paulstraße 5, Pernze
51702 Bergneustadt
Deutschland
Telefon +49 (0) 27 63-807-0
Telefax +49 (0) 27 63-807-77
E-mail verkauf@norwe.de
Internet www.norwe.de
www.norwe.eu

NORWE Inc.

P.O. Box 25 11
North Canton, OH 44720-0511
United States of America
Telefon +1-330 497-8113
Telefax +1-330 305-0592
E-mail usa@norwe.com
Internet www.norwe.com