

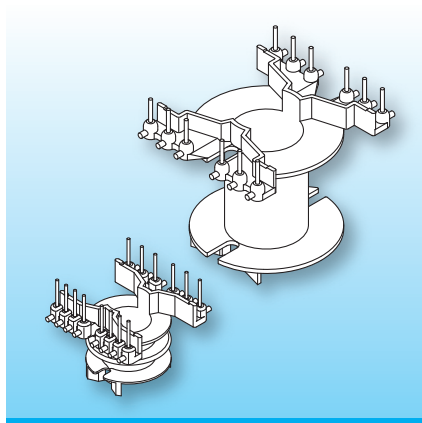

PQ Coilformers with Dual-in-Line Solder-pins.

The coilformers are made in gfr Polyethylene Terephthalate PET of type SKYT.5220FR (long-range temperature +155° C). Pin material: tin bronze, tinned. Maximum solder temperature 350° C for up to 2 sec. (Special materials – for example radiated cross-linked – and designs on request. Dimensions in mm/[inch](#)).



The coilformers with vertical axis are suitable for winding on the latest NC machines. The DIL pin configuration with radial “noses” ensures tension relieved axial binding-on of the wires. “Stand-offs” minimize cold-solder joints into the pcb.

Type	Order-Code	Accessories
Coilformer: PQ 20-16/1k/-6/ii/SKYT.5220FR	90359-186	on request
Coilformer: PQ 20-16/2k/-6/ii/SKYT.5220FR	N0501-186 	
Solder-pin: z609/ua	73265-212	

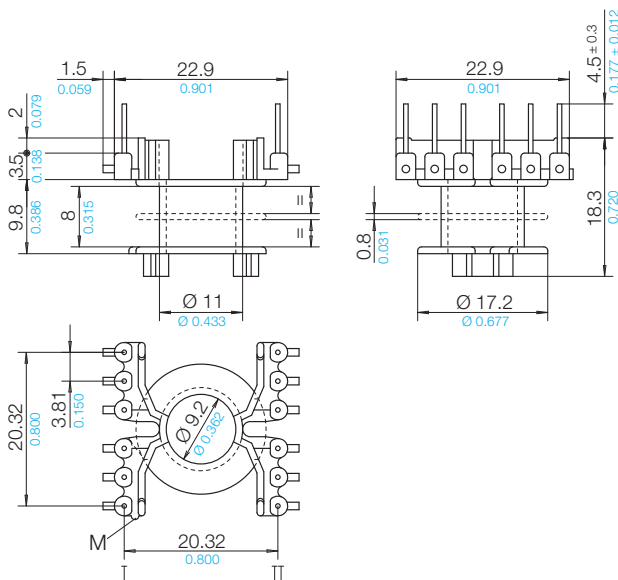

Grid View pin-side

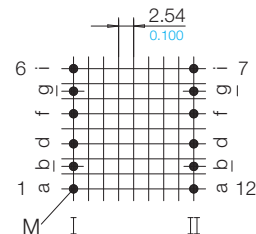

04 B 0 K

© 09/2022 by NORWE GmbH

All dimensions in mm/inch

The permissible deviations according to DIN 16901 apply as tolerances

Warranties: refer to Terms and Conditions of Sale



Valid version of data sheet online

QR Online-Version

NORWE GmbH

Paulstraße 5, Pernze
51702 Bergneustadt
Deutschland

Telefon +49 (0) 27 63-807-0
E-mail verkauf@norwe.de
Internet www.norwe.de
www.norwe.eu

NORWE Inc.

P.O. Box 25 11
North Canton, OH 44720-0511
United States of America

Telefon +1-330 497-8113
E-mail usa@norwe.com
Internet www.norwe.com