

PQ-Specials

The coilformers are made in gfr Polyethylene Terephthalate PET of type SKYT.5220FR (RTI long-range temperature +155°C). Special materials – e.g. irradiated cross-linked – and designs on request, dimensions in mm/*inch*.

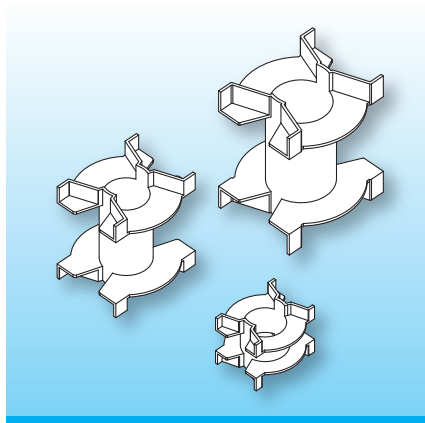

The coilformers are suitable for winding with thick wires, flat wires, round- or profiled litz wires and foils.

Type

Coilformer: PQ 20-16/SO/SKYT.5220FR

Order-Code

90501-186

Accessories

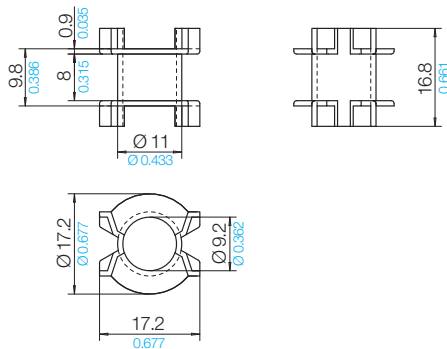

04 B 1 K

© 04/2024 by NORWE GmbH

All dimensions in mm/inch

The permissible deviations according to DIN 16901 apply as tolerances

Warranties: refer to Terms and Conditions of Sale



Valid version of data sheet online

QR Online-Version

NORWE GmbH

Paulstraße 5, Pernze
51702 Bergneustadt
Deutschland

Telefon +49 (0) 27 63-807-0
E-mail verkauf@norwe.de
Internet www.norwe.de
www.norwe.eu

NORWE Inc.

P.O. Box 25 11
North Canton, OH 44720-0511
United States of America

Telefon +1-330 497-8113
E-mail usa@norwe.com
Internet www.norwe.com