

RM Power Conversion 45°

The coilformers are made in gfr Polyphenylene Sulfide PPS of type torA504 (RTI long-range temperature +130°C).

Pin material: tin bronze, tinned.

Maximum solder temperature 300°C, 2 sec.

Special materials – eg. irradiated cross-linked – and designs on request, dimensions in mm/inch.

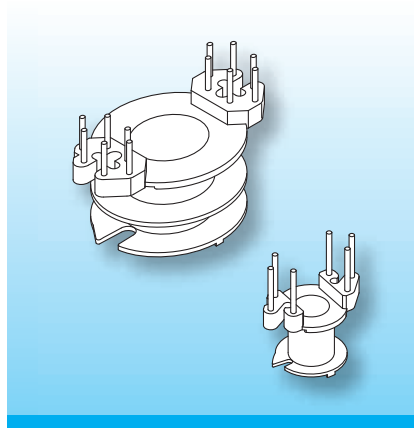

The coilformers are fitted with straight solder-pins. Binding-on of the wires is axially. The wires are guided into the winding room through centrally positioned slots in the lower flange.

A reinforced flange reduces the risk of breakage when binding-on the wire and ensures a tight fit of the solder-pins which are inserted after moulding.

Type	Order-Code	Accessories
Coilformer: RM 8/1k/12-6/torA504	60106-132	
Coilformer: RM 8/2k/12-6/torA504	60206-132	
Solder-pin: z607/ua	73263-212	

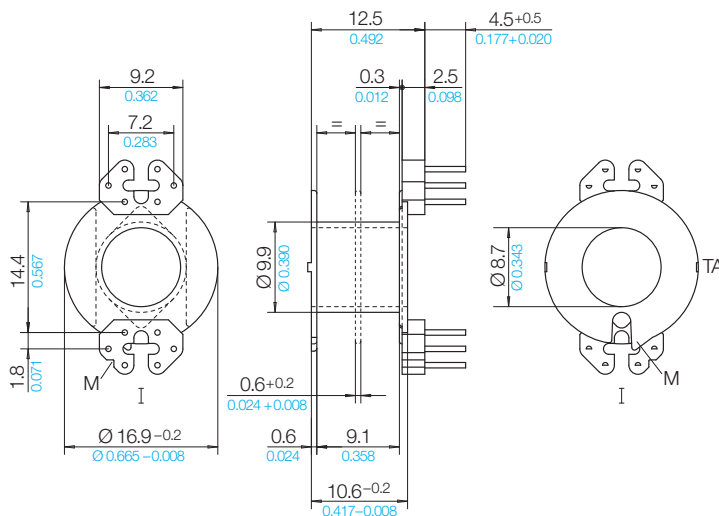

Grid View pin-side

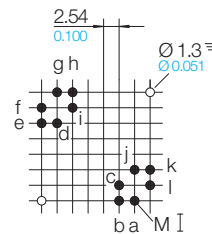

© 11/2011 by NORWE GmbH

All dimensions in mm/inch

The permissible deviations according to DIN 16901 apply as tolerances

Warranties:
refer to Terms and Conditions of Sale

NORWE GmbH

Postfach 13 56
51691 Bergneustadt
Paulstraße 5, Pernze
51702 Bergneustadt
Deutschland
Telefon +49 (0) 27 63-807-0
Telefax +49 (0) 27 63-807-77
E-mail verkauf@norwe.de
Internet www.norwe.de
www.norwe.eu

NORWE Inc.

P.O. Box 25 11
North Canton, OH 44720-0511
United States of America
Telefon +1-330 497-8113
Telefax +1-330 305-0592
E-mail usa@norwe.com
Internet www.norwe.com