

ETD Coilformers Horizontal

The coilformers are made in gfr Polyethylene Terephthalate PET of type SKYT.5220FR (RTI long-range temperature +155° C). Pin material is tin bronze, tinned for solder-pins and brass, tinned for solder-tags. Max. solder temperature +350° C, 2 sec. Special materials – e.g. irradiated cross-linked – and designs on request, dimensions in mm/*inch*.

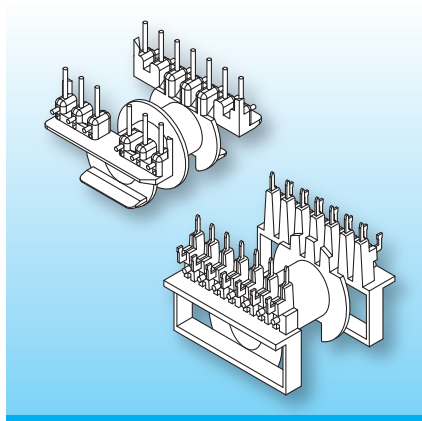

The coilformers are available in the latest design ETD lr and in the well-established versions ETD standard with solder-pins and ETD standard with solder-tags.

For each application the most suitable solution – inform yourself about the individual qualities of the different designs on catalogue-info.

Type	Order-Code	Accessories
Coilformer: ETD 29/lr/h13/-1/SKYT.5220FR	90572-186	Clip FK-ETD 29
Coilformer: ETD 29/lr/2k/h13/-1/SKYT.5220FR	90597-186	Potting Box ETD 29 hg/lr
Solder-pin: z112/ua	73322-212	Spacers DR

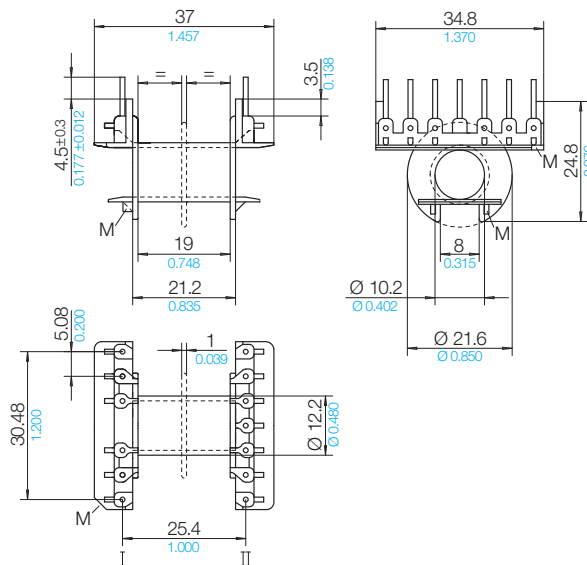

Grid View pin-side

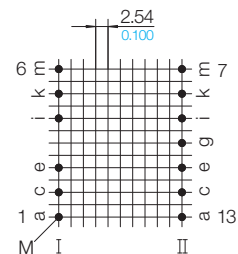

02 B 2 M / 02 B 2 G

© 09/2022 by NORWE GmbH

All dimensions in mm/inch

The permissible deviations according to DIN 16901 apply as tolerances

Warranties:
refer to Terms and Conditions of Sale



Valid version of
data sheet online

QR Online-Version

NORWE GmbH

Paulstraße 5, Pernze
51702 Bergneustadt
Deutschland

Telefon +49 (0) 27 63-807-0
E-mail verkauf@norwe.de
Internet www.norwe.de
www.norwe.eu

NORWE Inc.

P.O. Box 25 11
North Canton, OH 44720-0511
United States of America

Telefon +1-330 497-8113
E-mail usa@norwe.com
Internet www.norwe.com